

Moduline® Acoustic Enclosure System

Rugged Noise Control Structures Using Acoustically Rated & Field Proven Demountable Components



- Lab certified acoustic ratings
- Broad range of performance levels
- 63 Hz & 8 kHz sound transmission loss performance
- UL fire rated constructions
- Versatile modular constructions
- Simple to install, disassemble and reconfigure
- Durable powder coated finish



Represented by:





Moduline[®] Acoustic Enclosure System

Rugged Noise Control Structures Using Acoustically Rated & Field Proven Demountable Components

IAC Acoustics Moduline acoustic enclosures protect workers and the community from noise generated by manufacturing and power generating machinery. In industrial settings, noise from this equipment frequently exceeds OSHA limits for hearing safety while also impeding communication. Without noise control remediation, local noise ordinances at plant property lines may be exceeded. IAC Acoustics' line of acoustic enclosures are an effective and efficient way to address these problems.

IAC Acoustics offers standard packages for lighting, electrical and mechanical system components as well as the ability to fully customize the enclosure for unique customer requirements. When desired, electrical services can be integrated into the construction of the panel at the plant for a superior aesthetic and an unobstructed interior.

When you choose a Moduline Acoustic Enclosure, you can count on IAC Acoustics as the single point of responsibility for all the different components that affect the acoustic performance of the enclosure, including wall and roof panels, doors, windows and ventilation systems. IAC Acoustics professionals will work with you to identify and design the right solution to effectively mitigate your noise problem. We guarantee the performance of our products and continue to support our customers long after the job is complete.

IAC Acoustics Moduline Enclosures Offer:

- Integration of lighting, ventilation, fire fighting systems, air-conditioning, etc.
- Available sound and vibration isolating floor systems
- Designs for interior and exterior installation sites
- Available Noise-Lock[®] sound control door & window systems
- Installation services that can be included in IAC Acoustics' scope of supply

Moduline Acoustic Panels

Rugged, quickly installed, high-performance noise control systems with an infinite number of configurations and layouts. Included sound control doors, windows and ventilations systems ensure acoustic integrity and performance of the full structure.



Typical Moduline Applications

- Gen-Set Enclosures
- Compressor & Pump Package Enclosures
- In-Plant Offices
- Sound Isolating Building Partitions
- Machinery Enclosures
- Test Environments for Quality-Control & Product Development
- Acoustic/Thermal Plenums
- Transformer Sub-Station
- Communication Centers
- Observation/Control Rooms
- Vibration-Test Enclosures
- Control Pulpits
- Press Enclosures
- Equipment Penthouses
- Coordinate Measuring Machine Enclosures
- Cooling Tower Enclosure
- Outdoor Construction Offices
- Document Storage Rooms

Designing a Moduline Structure

IAC Moduline System features modular Noishield® and Noise-Lock® components with high sound transmission loss and sound absorption ratings providing excellent noise reduction characteristics. Components include acoustical wall, roof & floor panels, sound control doors and windows, ventilation units with integrated silencers, as well as panel joiners, trim & hardware — all part of an acoustically and structurally rated "building block" system for a multitude of applications.

1 Straight Walls / Barriers

A straight wall or barrier is the most basic of configurations and constitutes a starting point. The noise blocking Moduline panel wall may be part of a full enclosure or a partial barrier between existing walls. The panels are connected by 'H'-joiners and securely joined to the floor in a standard floor channel. A seal against other structures is made with angle connectors and felt stripping, cut to size and supplied with the components.

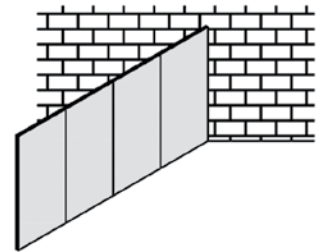

2 Partial Enclosures / Shields

Walls at right angles to the basic wall may be added by using a Moduline corner joiner. If other than a right angle connection is desired, angular joiners are used.

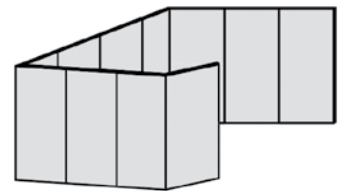

3 Access to Enclosed Equipment

Sound control doors for personnel and materials access, and acoustically rated windows for visibility are included in IAC Acoustics' Moduline system. No-sill personnel access doors framed openings and a wide range of hinged single and double-leaf doors with magnetic seals are all available. For visibility, IAC Acoustics standard Noise-Lock® double-glazed windows range from 12" x 12" (305 x 305 mm) to 27" x 74.5" (686 x 1892 mm).

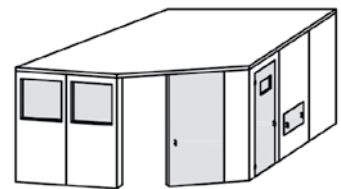

4 Roof for a Complete Enclosure

Moduline roof constructions are similar to that used for walls. Standard 'H'-joiners, roof channels and a perimeter apron provide the necessary structural and acoustical seals and may be used for most spans. When the roof must support more than its own weight or clear spans are large, spans a special 'H'-joiner or structural steel is utilized.

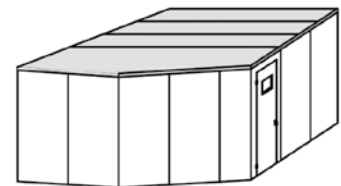

5

Floors & Vibration Control

To provide vibration isolation and address structurally transmitted noise, Moduline enclosures can be built with an integrated acoustic floor supported on vibration isolators kits.

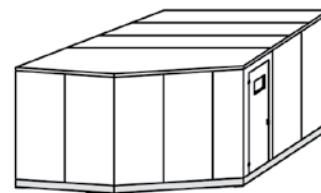

6

Ventilation for Complete Enclosures

Moduline ventilation systems for both low and high-volume flow designs are available for both Noishield® and Noise-Lock® constructions. Integrated noise control packages and connections to a host building HVAC system are available for all enclosures, including personnel shelters and test environments.

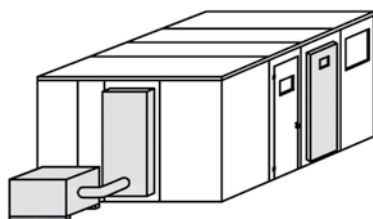

Test Environments

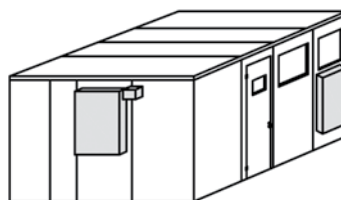

Machinery Enclosures

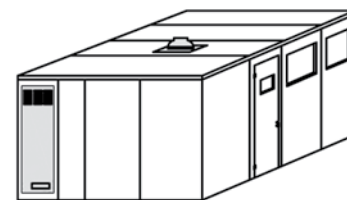

Personnel Structures



Versatile Components & Installation

Walls, Ceilings & Floors

- Moisture protection for absorption materials prevents entrapment of volatile or corrosive liquids
- Noise-Foil® sound absorption system reduces reverberant build-up within existing "hard" structures
- Optional Fire-Noise-Lock® construction provides certification of 1.5 hour fire rating — all components shipped with UL label

Doors & Other Accessories

- Single and double-leaf "Cam-Lift", no-sill personnel doors. Clear opening to 8' x 14' (2438 x 4267 mm). Special designs for larger openings available.
- Panic hardware
- Manual and automated single and double-leaf sliding doors
- Removable panel details — all hardware captive
- Access plugs for local access
- Double-glazed window units provide visibility at no loss of acoustic integrity
- UL fire-rated doors — 3 hours — up to 42" x 90" (1067 x 2286 mm) single-leaf clear opening. 84" x 90" (2134 x 2286 mm) double-leaf clear opening.

Standard Materials

- Cold-rolled solid steel and galvanized steel with a durable powder coated finish

Optional Materials

- All galvanized construction
- Special stainless constructions — contact IAC Acoustics for additional details

Ventilation

- Acoustically compatible systems — 100-10,000 cfm (170-17,000 m³/hr)
- Wide range of acoustically and aerodynamically rated silencers for normal & most exacting requirements

Installation Information & Sequence

- Two technicians can handle Moduline components
- Doors installed just like other panel components, with leaves shipped pre-assembled in a frame
- Place floor channels in lengths needed for room perimeter & anchor to floor
- Starting at a corner, install panels & joiners to make up walls
- Install roof angles, place ceiling panels & joiners, and finish off with external roof apron
- Install accessory items, including forced ventilation system and electrical work
- Use easy to follow, detailed & illustrated installation instructions provided with each structure

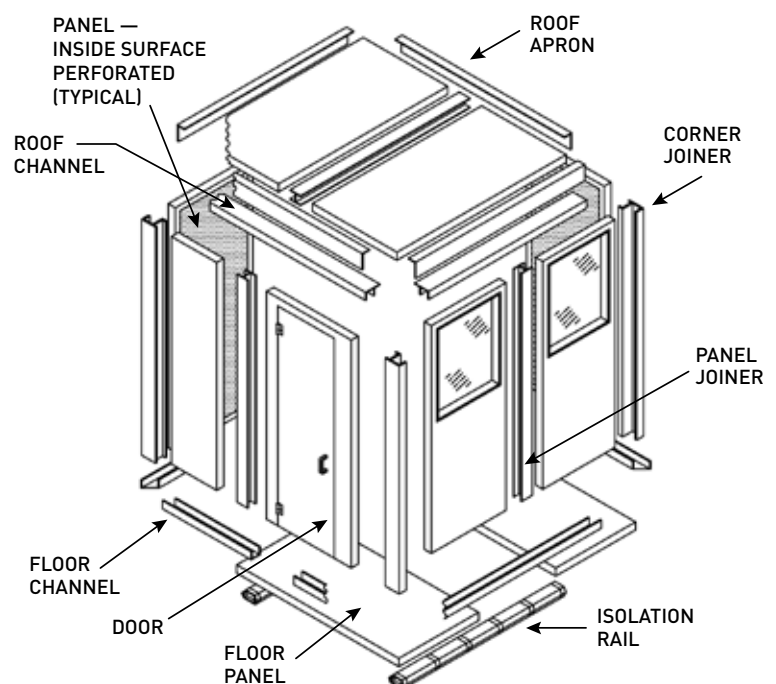

Moduline Acoustic Performance

| Moduline Construction Type | Sound Transmission Loss, dB, by Octave Band Center Frequency, and Sound Transmission Class, STC, Rating | | | | | | | | | |
|---------------------------------|---|-----|-----|-----|----|----|----|----|-----|--------------------------|
| | 63 | 125 | 250 | 500 | 1k | 2k | 4k | 8k | STC | WT lb/ft ² |
| Noishield Regular | 20 | 21 | 27 | 38 | 48 | 58 | 67 | 66 | 40 | 8 |
| Noishield Septum | 21 | 19 | 23 | 35 | 50 | 60 | 68 | 72 | 37 | 9 |
| Mill Duty Regular | 28 | 27 | 28 | 41 | 50 | 57 | 57 | 64 | 43 | 10.5 |
| Noise-Lock I | 25 | 27 | 31 | 41 | 51 | 60 | 65 | 66 | 44 | 10 |
| Noise-Lock II & Fire-Noise-Lock | 27 | 30 | 32 | 41 | 50 | 59 | 67 | 71 | 45 | 11 |
| Super-Noise-Lock | 31 | 34 | 35 | 44 | 54 | 63 | 62 | 68 | 48 | 15 |
| Noishield Hard | 22 | 33 | 45 | 52 | 58 | 68 | 75 | 65 | 56 | 9.5 |
| Noise-Lock III | 20 | 36 | 51 | 68 | 75 | 83 | 84 | 73 | 59 | 11 |
| Noise-Lock II Hard | 24 | 40 | 50 | 57 | 65 | 73 | 80 | 78 | 61 | 12 |
| Noise-Lock IV Hard | 21 | 30 | 50 | 60 | 73 | 79 | 80 | 71 | 62 | 11.3 |
| Gemini Regular | 34 | 48 | 58 | 69 | 75 | 82 | 86 | 76 | 70 | 21 |

| Panel Construction Type | Sound Absorption Coefficients at Octave Band Center Frequency, and Noise Reduction Coefficient, NRC | | | | | | | |
|--|---|------|------|------|------|------|------|-------------|
| | 125 | 250 | 500 | 1k | 2k | 4k | 8k | NRC |
| Noishield Regular | 0.89 | 1.20 | 1.16 | 1.09 | 1.01 | 1.03 | 0.93 | (1.10)/0.95 |
| Noishield Septum | 0.50 | 0.68 | 1.03 | 1.05 | 1.00 | 0.99 | — | (1.10)/0.95 |
| Noise-Lock I, II, Fire-Noise-Lock & Super-Noise-Lock | 0.94 | 1.19 | 1.11 | 1.06 | 1.03 | 1.03 | 1.04 | (1.10)/0.95 |
| Noishield Regular with fill protection & spacer | 0.56 | 0.99 | 1.09 | 0.97 | 0.95 | 0.90 | — | (1.10)/0.95 |
| Noise-Lock III | 0.49 | 0.37 | 0.83 | 0.96 | 0.99 | 1.00 | — | 0.80 |
| Noise-Foil I & II (2" - 51 mm thick) | 0.35 | 0.65 | 1.20 | 1.21 | 1.07 | 0.92 | — | 0.95 |
| Noise-Foil I & II (4" - 102 mm thick) | 0.97 | 1.39 | 1.34 | 1.29 | 1.19 | 1.01 | — | 1.30 |
| Noise-Foil V | 0.24 | 0.95 | 1.13 | 0.99 | 0.94 | 0.86 | — | 1.00 |

Fire Resistance Ratings

Fire-Noise-Lock™ panels ship with UL labels certifying 1-hour (solid side) and 1.5-hour (absorptive side) fire ratings. Doors are certified and ship with UL fire ratings available up to 3 hours.

Blast Resistance

Moduline structures and components can be designed to withstand blast loads, with doors remaining operable after blast — please contact the factory for details.



iac acoustics
A DIVISION OF SOUNDS BEAT

Represented by:



2420 Grenoble Road
Richmond, VA 23294
Toll Free: 800.782.5742
<https://acousticalsolutions.com/>

