

Fabric Wrapped Panel Installation Guide

SELECT THE METHOD OF MOUNTING

Impaling Clips | Rotofast Snap-On | Z-Clips

These installation instructions are given as a general guide to avoid common errors. Installer should follow best practices for construction and workmanship. Acoustical Solutions bears no responsibility for installation or contractor selection. Please contact a sales representative if you have questions, concerns or specific project requirements.

Be sure to inspect materials upon delivery. Please note any damage on the delivery ticket and notify Acoustical Solutions immediately. Materials should be stored in original packing in a clean, climate controlled environment free of moisture. Installation should not commence until building is enclosed and under standard occupancy conditions and surfaces are of acceptable condition and properly prepared. Do not install materials of unacceptable quality.



Fabric Wrapped Panel Installation: Impaling Clips

INSTALLATION METHOD

Determine the location of where the panel(s) will be mounted to the wall. Lightly mark outside edge of location for the top, bottom, left and right of the panel. Mount impaling clips to the wall surface using the appropriate fastener or hot melt adhesive. Impaling clips should be set in at least six inches from the outer edge of the panel to avoid the fabric on the back of the panel. Apply a generous amount of construction adhesive (not included) to the back of the fabric-wrapped panel. Line up the panel to the marks on the wall and firmly push the panel down onto the impaling clips to impale the clips into the fiberglass core. Verify panels are straight and plumb with a level. Impaling clips will hold the panel in place while the adhesive sets. Repeat this process for multiple panels.

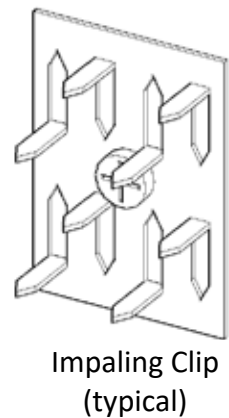
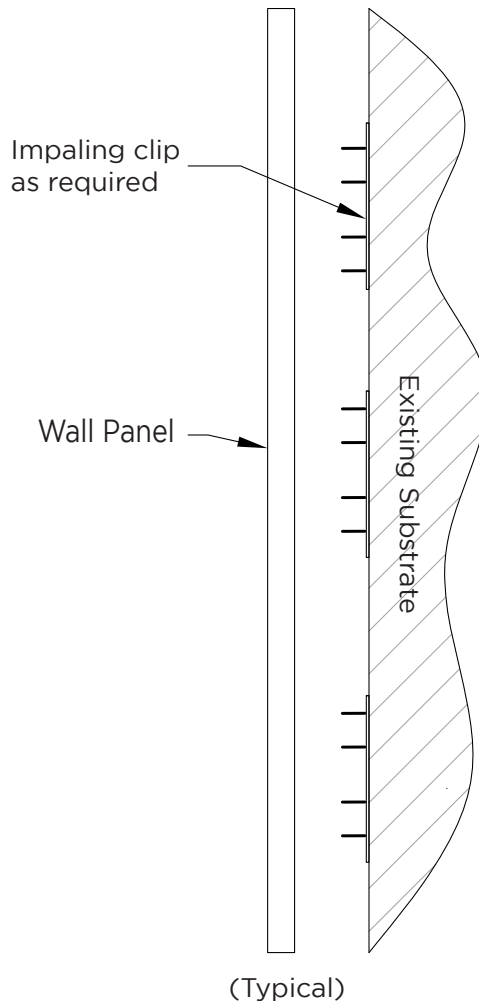
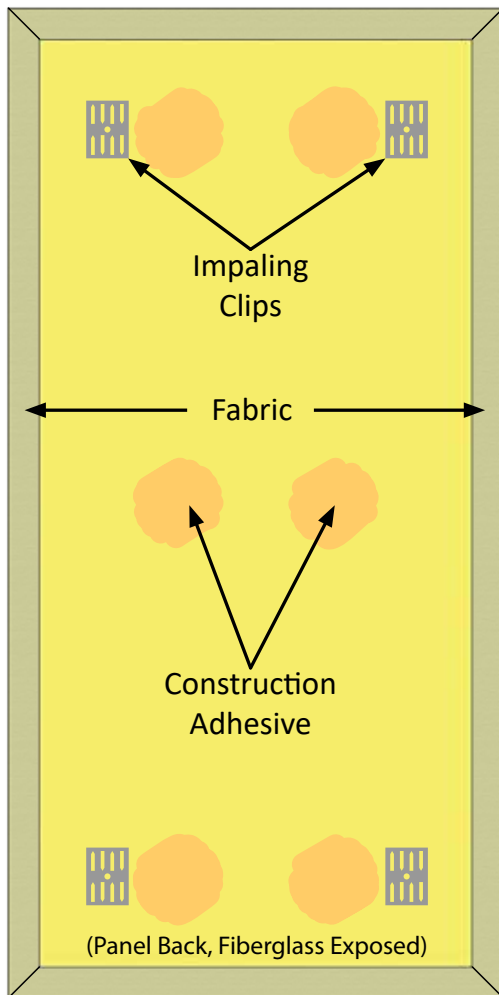

PANEL SIZE	TYPICAL # OF CLIPS
2'x2', 1'x4'	2
2'x4' - 2'x5'	4
2'x6' - 2'x8'	6
4'x4'	4
4'x5', 4'x6'	5
2'x10', 4'x8'	8
4'x10'	10



Fabric Wrapped Panel Installation: RotoFast Snap-On



STEP 1

In most cases, the Rotofast Snap-On anchors will be factory mounted into the back of the acoustical panel. If so, continue to step 2. If not, screw the Rotofast Snap-On Anchors into the back of the panel using a hex driver tool.



STEP 2

Insert the marking plugs into the Rotofast Snap-On Anchors. The point of the marking plug should be facing away from the back of the panel.

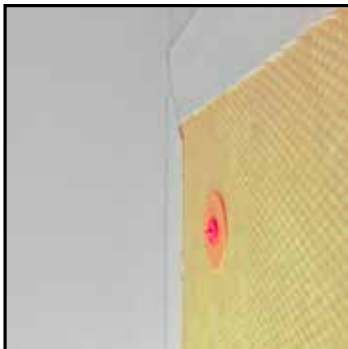

STEP 3

Push the panel firmly against the wall to mark all anchor locations.

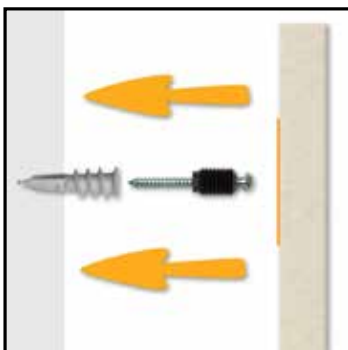

STEP 4

Screw Ratchets to wall at marked locations using appropriate wall or ceiling anchors. EZ anchors are provided for use with drywall only. Use other anchors as required. Once ratchets are secured to the wall, firmly push the panel anchors onto ratchets to complete installation.



Fabric Wrapped Panel Installation: Z-Clips

INSTALLATION METHOD

Z-clips are a two part mechanical fastener used to mount acoustical panels to a wall. Z-clips will be factory mounted to the back of the panel. Mating wall z-clips are supplied with the order. Determine the location and layout of where the panel(s) will be mounted to the wall. Mirror mounting locations from panel onto the wall to line up with the z-clips on the back of the panels. Create reference lines on the wall to ensure panels will mount plumb and level. Secure z-clips to the wall using appropriate fasteners. Slide panel z-clips onto wall z-clips. Repeat process for multiple panels.

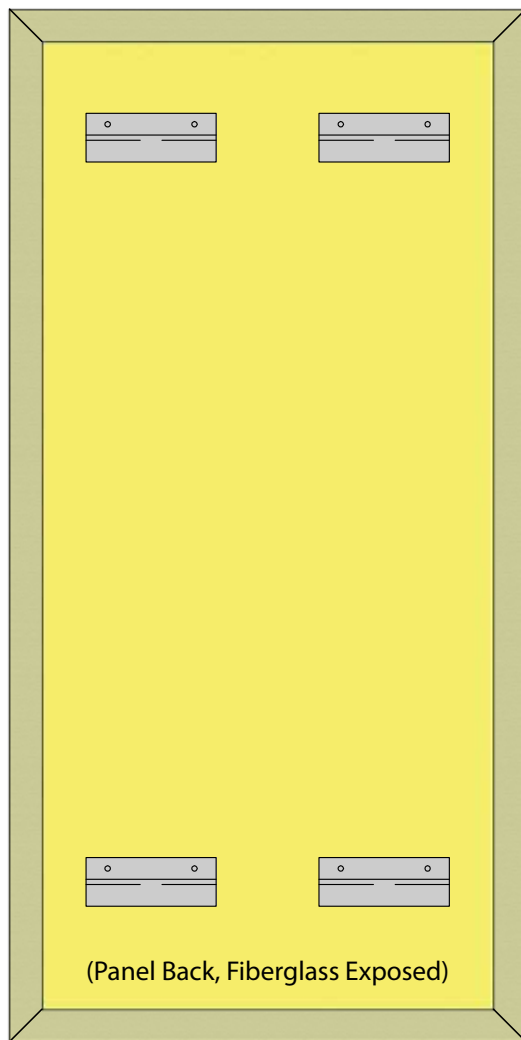

(Typical)

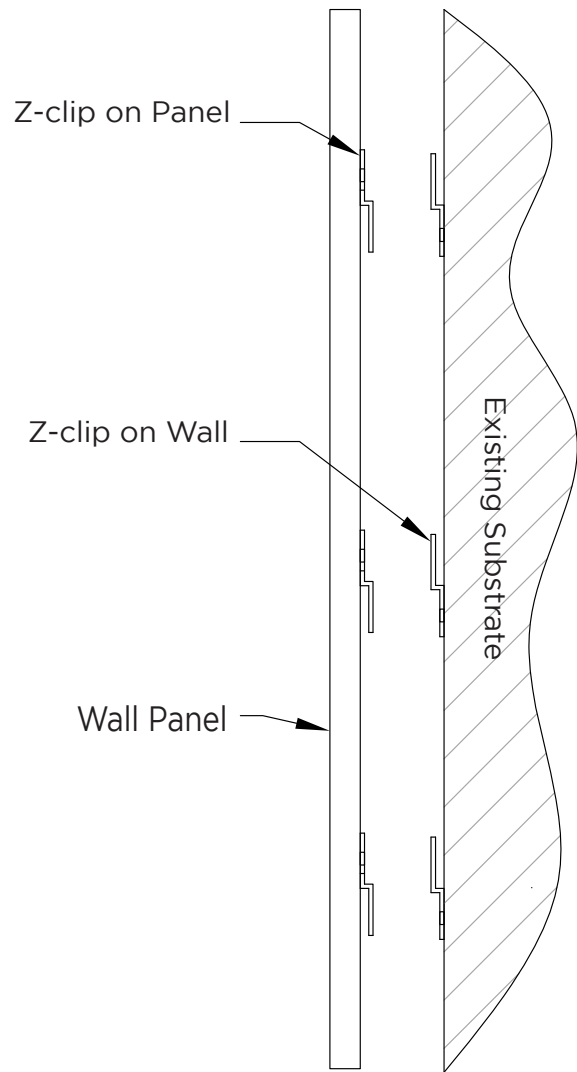

(Typical)



Fabric Wrapped Panel Installation: Z-Clips

1) Layout panel location(s) on the wall

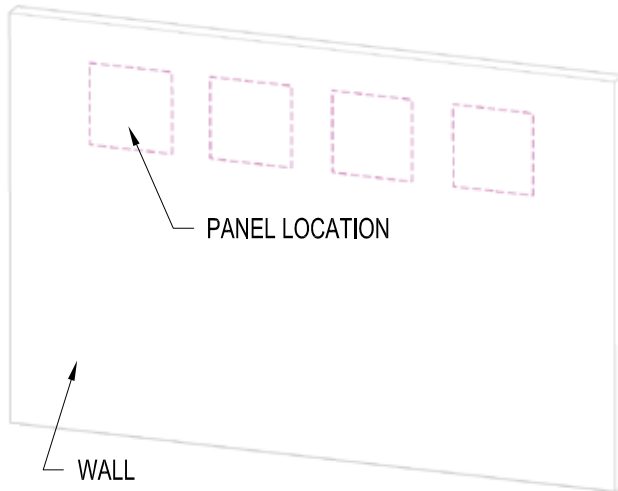

2) Determine Z-clip locations on wall, brackets should line up with the factory installed z-clips on the back of the panel.

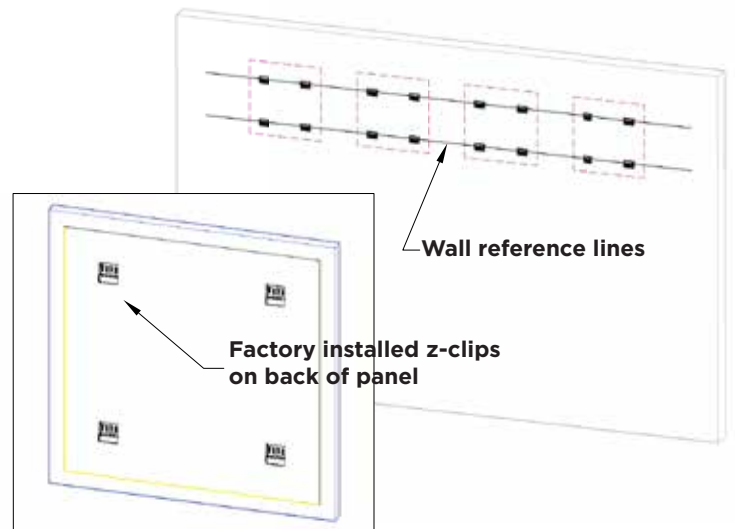

3) Secure z-clip wall plate to wall with appropriate fasteners

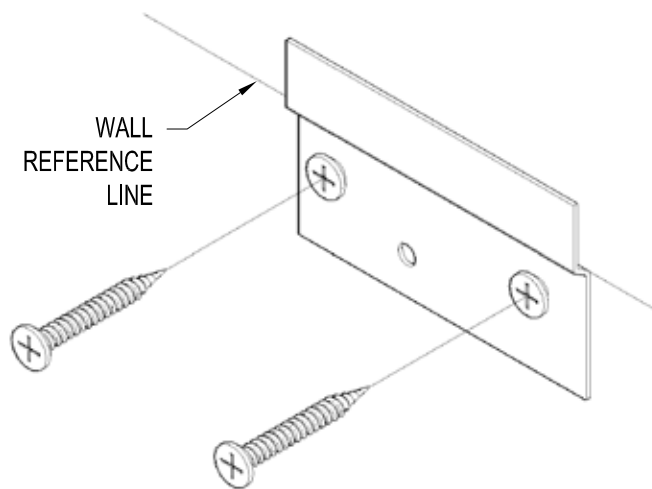

4) Slide the Z-clips attached to the panel onto the z-clips attached to the wall.

