

ALPHASORB SERIES 300 POLYESTER ACOUSTIC BAFFLES UNISTRUT INSTALLATION INSTRUCTIONS

IMPORTANT: These instructions are for Unistrut Installations only

These installation suggestions consist of a common process for tile installation. Installers should rely upon their own professional experience and understanding of their unique requirements to ensure a successful install.

Confirm your Unistrut installation has been completed. Consult with a professional about a proper Unistrut installation for your ceiling type (concrete vs. sheet-rock).

TOOLS NEEDED



Drill

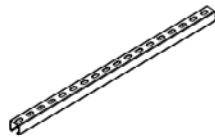

Unistrut installed



Cable Cutter



Nylon Cone
Nut



1/4-20
Nut

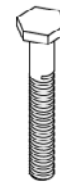

1/4-20
Bolts



Fender
Washer

ITEMS INCLUDED

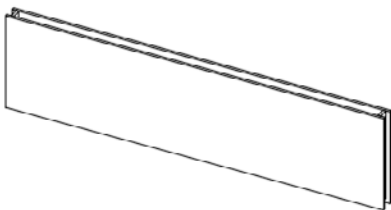

Baffle

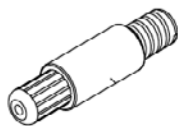

(2) Griplock



Hanger Bolt Driver
(IVY classic)



(2) Hanger Bolt



(2) Coupler Nut



(2) Aircraft Cable or (2)
Threaded Rod



ALPHASORB SERIES 300 POLYESTER ACOUSTIC BAFFLES UNISTRUT INSTALLATION INSTRUCTIONS

1. Unwrap baffle from plastic wrap. Confirm baffle dimensions match your needs.

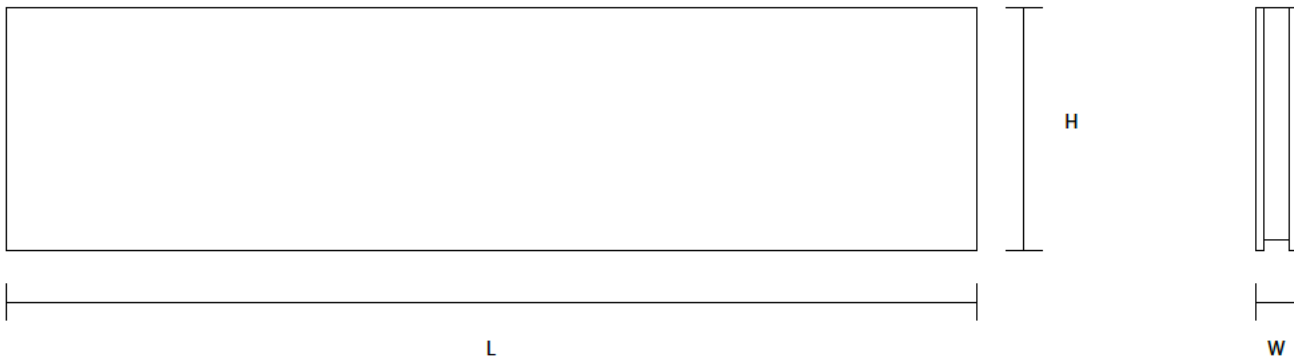

If your baffle is pre-drilled with hanger bolts inserted, go to step 4.

2. If your baffles came without pre-drilled hanger bolts, follow this step: Measure the distance between the two Unistruts that will be holding the baffle. Match your hole location distance to the distance of the Unistruts. Use a drill machine to make a 1/8" pilot hole for hanger bolts.

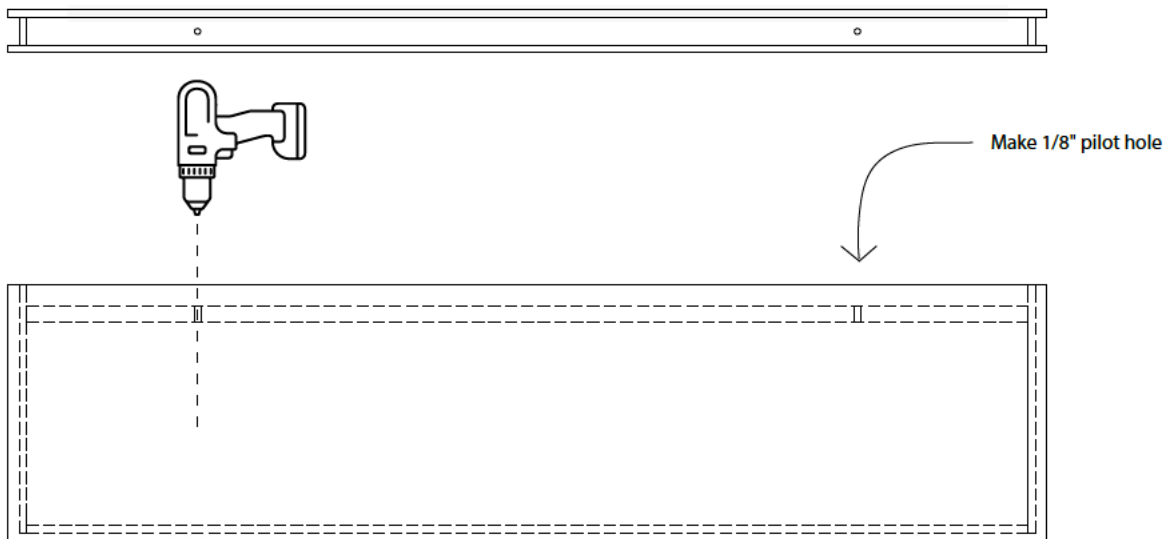

ALPHASORB SERIES 300 POLYESTER ACOUSTIC BAFFLES UNISTRUT INSTALLATION INSTRUCTIONS

3. Use 1/4" - 20 hanger bolt driver tool to drive bolt into place, leaving 3/2" of the 1/4" - 20 threads exposed.

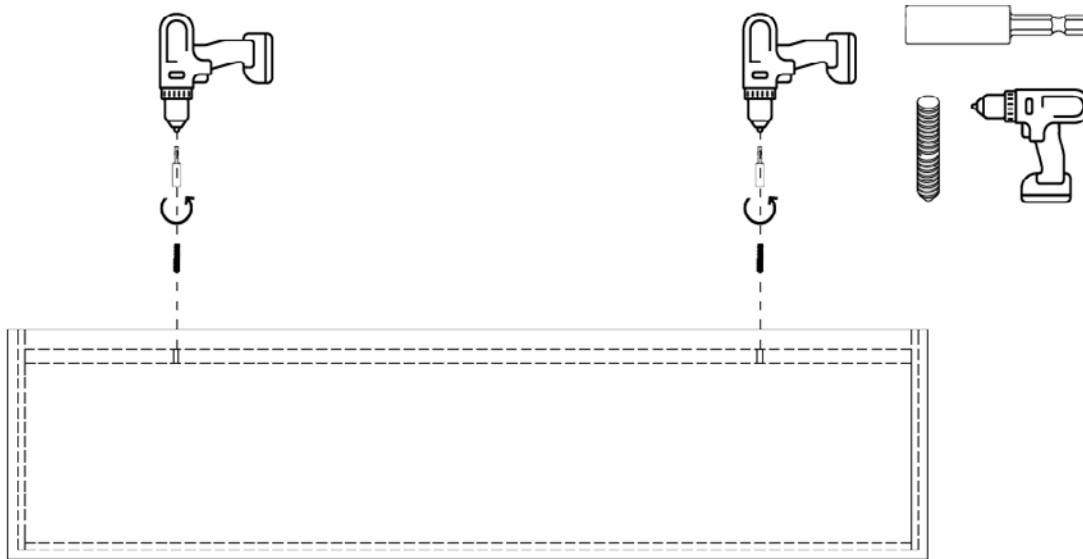

4. Screw the coupling nut all the way on to the hanger bolt.

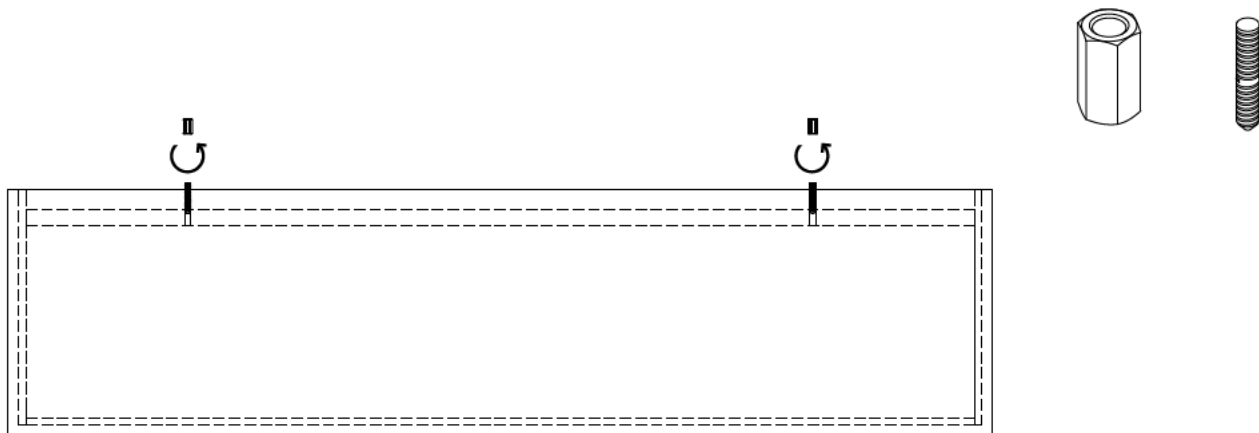

ALPHASORB SERIES 300 POLYESTER ACOUSTIC BAFFLES UNISTRUT INSTALLATION INSTRUCTIONS

5. Install Threaded Rod or Aircraft Cable from Unistrut

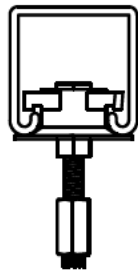
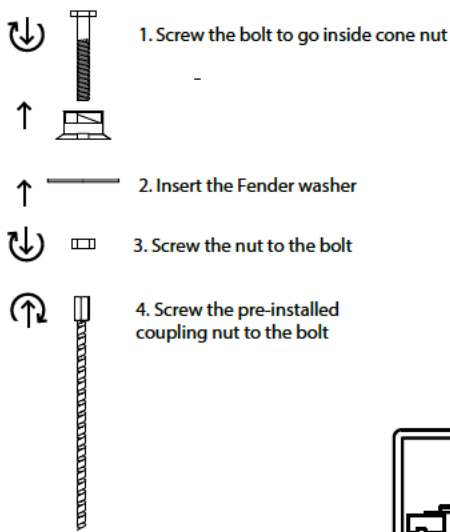

Threaded Rod

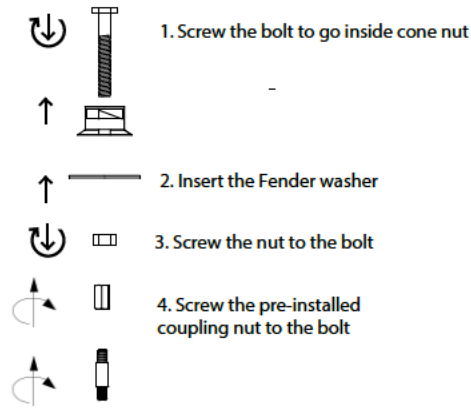

Aircraft Cable



ALPHASORB SERIES 300 POLYESTER ACOUSTIC BAFFLES UNISTRUT INSTALLATION INSTRUCTIONS

6a. Threaded Rod Specific Step ONLY Cut 1/4" threaded rod at desired length and screw in half way into the coupler nut.

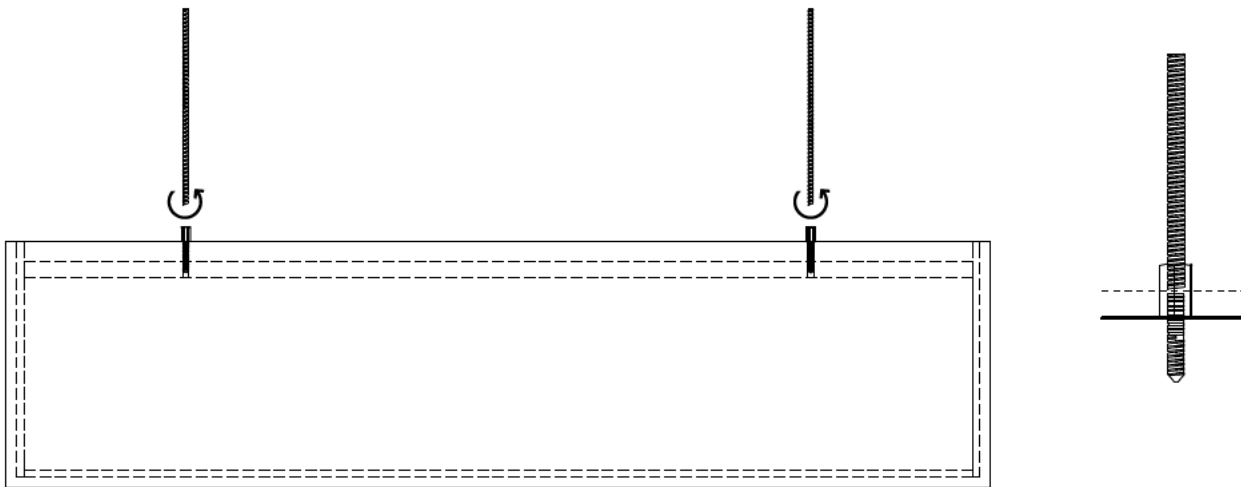

6b. Aircraft Cable Specific Step ONLY. Cut the excess cable using cable cutter.

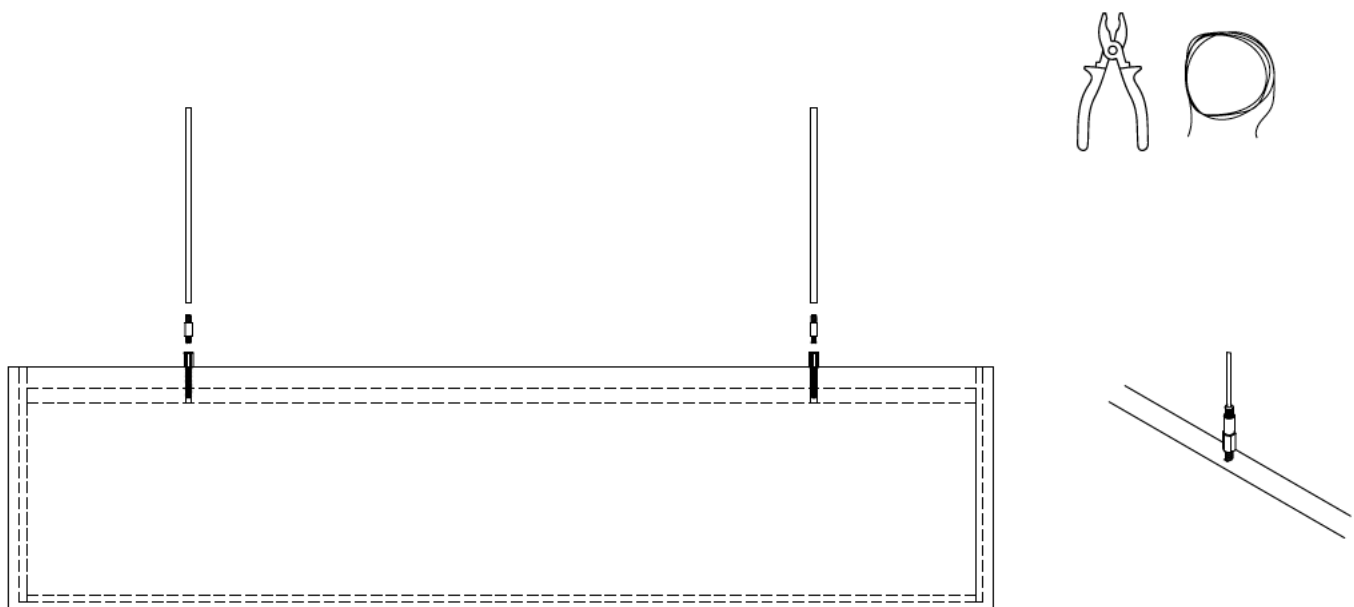

ALPHASORB SERIES 300 POLYESTER ACOUSTIC BAFFLES UNISTRUT INSTALLATION INSTRUCTIONS

7. Final view

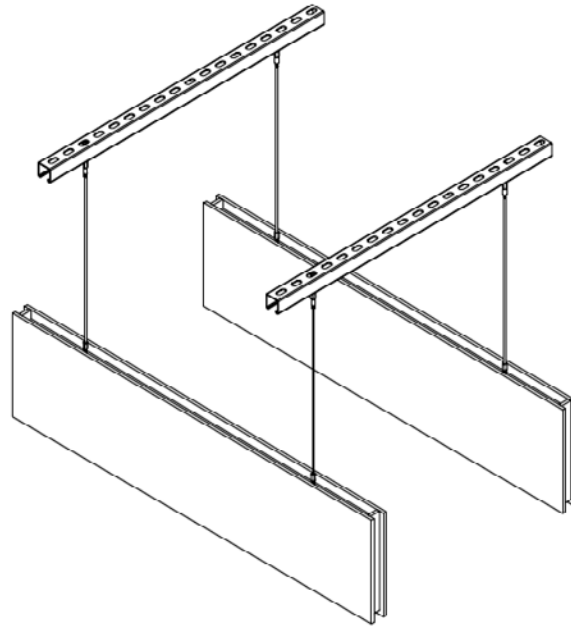

Threaded Rod

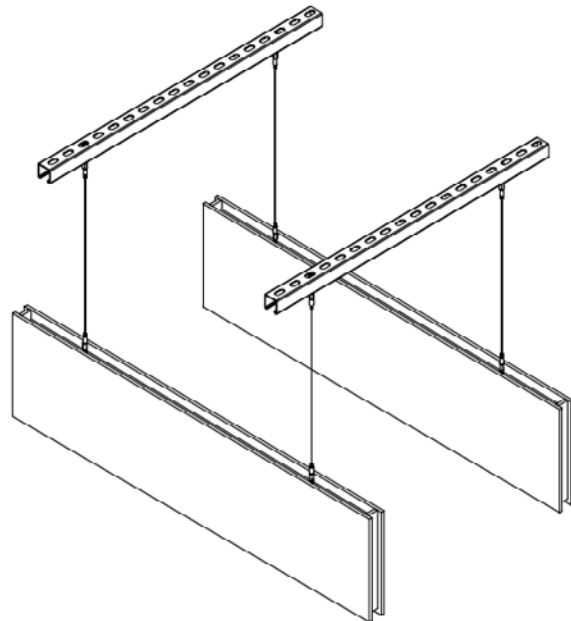

Aircraft Cable

