

ALPHASORB[®] DESIGNER PREMIUM ACOUSTIC FELT HEXAGON WALL PANEL INSTALLATION GUIDE

These installation suggestions consist of a common process for installation. Installers should rely upon their own professional experience and understanding of their unique requirements to ensure a successful installation professional experience and understanding of their unique requirements to ensure a successful install.

TOOLS NEEDED

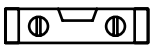

Level



Putty Knife



Construction
Adhesive*

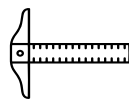

Straight Edge

*Liquid Nails (heavy duty) or Robert 3095 Carpet Adhesive

ITEMS INCLUDED

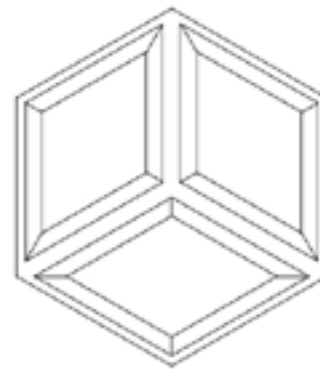

Tiles

1. Measure the length and height of the wall. Find center of the wall.

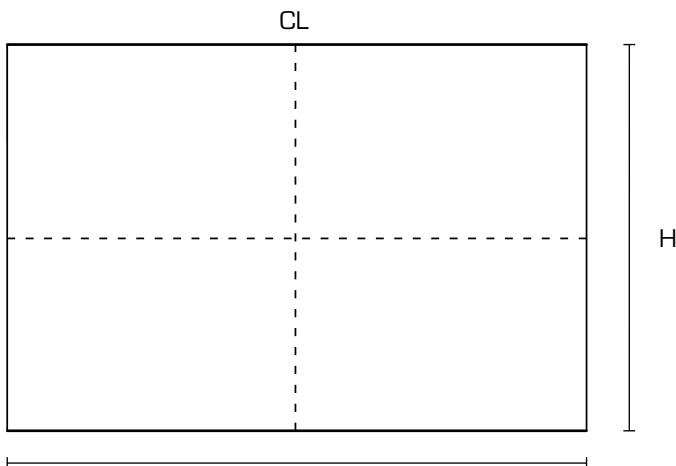

ALPHASORB[®] DESIGNER PREMIUM ACOUSTIC FELT HEXAGON WALL PANEL INSTALLATION GUIDE

2. Lay the tile down on the ground and flip the puffed face down.

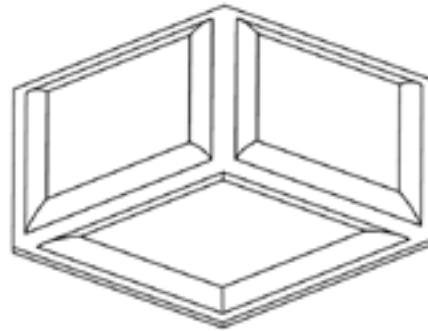

3. Use the putty knife to place the carpet adhesive to one tile at a time. Working on one tile at a time, apply a liberal amount of adhesive to the back of the panel utilizing the adhesive manufacturers best practices.

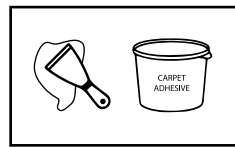
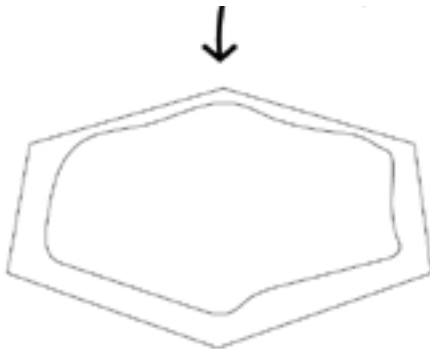

OR

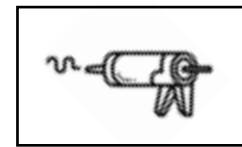

* Robert 3096 Carpet Adhesive or
Liquid Nails (heavy duty)

4. Position the tile on the wall on predetermined location. Hold it until it's dry.
Continue similar procedure for the rest of the tiles until the installation is complete.

